

*Chairman*  
***Playman***  
*Owner's manual*





# How to contact Permobil

## **Permobil Inc. USA**

6961 Eastgate Blvd.  
Lebanon, TN 37090  
USA

Phone: 800-736-0925  
Fax: 800-231-3256  
Email: [info@permobilus.com](mailto:info@permobilus.com)

## **Head Office of the Permobil group.**

### **Permobil AB**

Box 120, 861 23 Timrå, Sweden  
Tel: +46 60 59 59 00. Fax: +46 60 57 52 50  
E-mail: [info@permobil.se](mailto:info@permobil.se)

*Chairman*  
***Playman***  
*Owner's manual*

Produced and published by Permobil AB, Sweden  
Edition no. 2, 2002-01  
Order no: 201184-US-0  
PABnr: 1184:2

# Contents

<b>Safety instructions</b> .....	6
<b>General introduction</b> .....	8
Specially modified wheelchair .....	8
<b>Design and function</b> .....	9
General .....	9
Seat .....	10
Seat lift .....	10
Wheels .....	11
Lighting and reflectors .....	11
Electrical system .....	12
Control panel .....	14
<b>Accessories</b> .....	22
Tool bag .....	22
<b>Handling</b> .....	23
General .....	23
Driving .....	23
Driving rules .....	26
Releasing the brakes .....	28
Charging the batteries .....	29
<b>Transport</b> .....	31
Transporting by air .....	32
<b>Maintenance and repairs</b> .....	33
General .....	33
Cleaning .....	34
Wheels .....	34
Releasing the brakes .....	34
Batteries .....	34
<b>Repairs</b> .....	35
Changing fuses .....	35
Changing bulbs .....	36
Changing batteries .....	37
Changing inner tube .....	39
Filling with air .....	39
<b>Technical specifications</b> .....	40
<b>Important information</b> (only for the US market) .....	41

# Safety instructions

## General

An electric wheelchair is a motorized vehicle and special care must, therefore, be taken when it is used.

Incorrect use may both injure the user and damage the chair. In order to reduce these risks, you should read the Owner's Manual carefully, in particular the safety instructions and their warning texts.

Any inappropriate modifications to the wheelchair and its various systems may entail an increased risk of accidents. Carefully follow the recommendations in the Handling section to prevent the risk of accidents in connection with driving.

All modifications to and interventions in the vital systems of the wheelchair must be performed by a qualified service technician. Always contact a qualified service technician in cases of doubt.

## Warning



**WARNING !**

**Please show great caution where this warning symbol appears. There is a risk of personal injury.**

## Maximum weight of user

The Chairman Playman can be used by someone weighing up to 77 lbs.

## Passengers

It is absolutely forbidden to carry passengers on the wheelchair.

## Operation

Do not let children drive the wheelchair without supervision.

Do not drive the wheelchair over any edges higher than 2.5".

When driving downhill, select the slowest speed and proceed with caution. The wheelchair is not designed for driving down slopes with a gradient greater than 12°\*).

Do not drive up slopes with a gradient greater than 12°. There is a risk that the wheelchair will not maneuver safely.

Do not drive the wheelchair where the sideways gradient is more than 6°. There is a risk of tipping over.

*\*)Dynamic stability according to ISO 7176-2 = 6°*

## **Operating the seat lift**

Ensure that nothing is caught between the chassis and the seat when the seat lift is operated. Raising the seat lift raises the center of gravity and increases the risk of tipping. Therefore, you should only use the seat lift on level ground and not on hilly ground.

## **Driving on loose or soft surfaces**

When the chair is set to the lowest speed, and the batteries are not fully charged, driving on certain surfaces, such as gravel, sand and thick carpets, may result in restricted movement.

## **Getting into and out of the chair**

The wheelchair must always be switched off and the brakes on / engaged when getting into and out of the chair.

## **Releasing the brakes**

In order to avoid the wheelchair rolling away, ensure that the wheelchair is on a level and dry base before releasing the brakes.

## **Charging the batteries**

The batteries must be charged in a well-ventilated room, not in a closet. Do not charge the batteries in a bathroom or wet room. Use only chargers with a maximum 10 A charging current (mean value). When the charger is connected, the chair must not and cannot be driven.

## **Transport**

Ensure that the wheelchair is properly secured (see page 31). If the chair is not properly secured and comes loose, it can cause serious injury to persons in the vehicle and serious damage to the vehicle.

## **Servicing**

Servicing and maintenance by the user should be restricted to tasks designated as suitable for home servicing in the instruction book. All other servicing and maintenance tasks must be carried out by persons with sufficient knowledge to ensure a competent result.

When working on the wheelchair's electrical system, the connection to the positive pole on the battery must always be removed.

Take care with metal objects when working on the batteries. A short circuit could easily cause an explosion. Always wear protective gloves and goggles.

Make sure nothing is trapped between the chair chassis and the seat when operating the seat lift.

Recommended air pressure is 29 psi. Over-inflation could cause an explosion.

The seat is heavy and must be handled with care to avoid personal injury.

## General introduction

To gain the maximum benefit from the chair it is important to use it in the intended manner. Please, therefore, read these User Instructions thoroughly, especially the safety precautions. Keep the User Instructions together with the other wheelchair items.

Your first task is to charge the batteries. Read the chapter on Batteries if you are uncertain how to do this. Charging takes about eight hours.

### **Specially adapted wheelchairs**

If your wheelchair is marked "specially adapted product", it has been adapted to your needs and purposes. This means that the design and function may differ from these User Instructions, or from the design and function of other Permobil's of the same type.

The design and function of your wheelchair will be communicated in the written or verbal instructions given when the chair is delivered.

### **Specifications**

All information and specifications in these User Instructions were correct at the time of delivery of this wheelchair. As developments and improvements are constantly being made by Permobil, we reserve the right to make changes without prior notice.



# Design and Function

## General

Overview of the Chairman Playman.

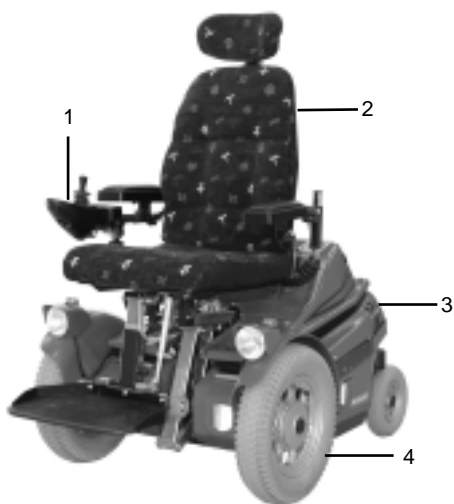

*Fig.1. Chairman Playman, front view*



*Fig.2. Chairman Playman, rear view*

- |                  |                       |
|------------------|-----------------------|
| 1. Control panel | 4. Drive wheel        |
| 2. Seat          | 5. Electric seat lift |
| 3. Chassis       | 6. Rear wheel         |

## Seat

See the supplied Owner's Manual for the seat.

## Seat lift

The Chairman Robo is equipped with a unique seat lift system which makes it possible to adjust the height of the seat from 6" to 28".



*Fig.3 Highest position*



*Fig.4 Lowest position*

## Wheels

The wheelchair's front wheels, the drive wheels, have pneumatic tires. The rear wheels, the steering wheels, have solid rubber tires.

## Lights and reflectors

The wheelchair is equipped with reflectors at the front, rear and sides (L model) and front/rear lights and indicators (S model).

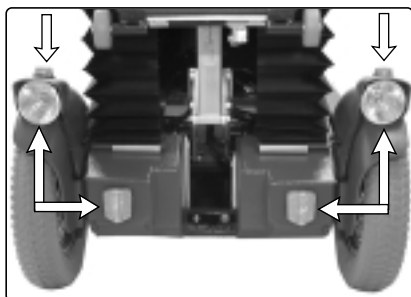

*Front*

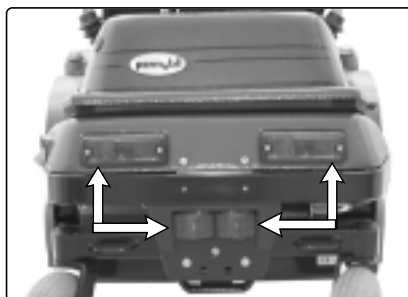

*Rear*

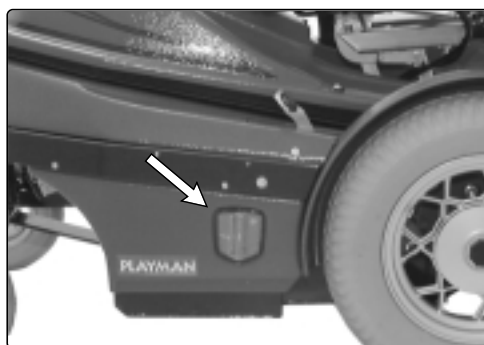

*Side*

*Fig.5 Lights, indicators and reflectors*

## Electrical system

The wheelchair's batteries are located under the battery cover in the center of the chassis

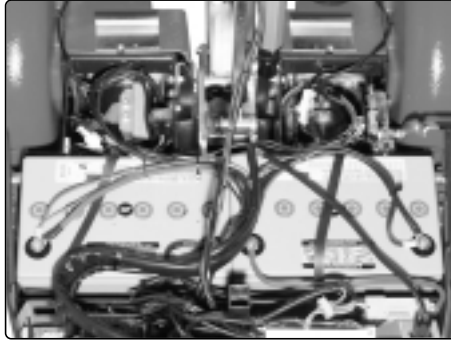

*Fig.6. Batteries*

## Driving

The wheelchair has a drive pack for each drive wheel. The motors regulate the speed, turning and braking. A joystick on the maneuvering panel sends signals to the electronics unit placed under the cover on the rear part of the chassis. The electronics unit then controls the motors.



*Fig.7. Electric motor with driving gear*

## Main circuit-breaker

You can reset the main circuit-breaker if it trips. It is on the underside of the chassis, over the right, rear wheel, see fig. 8. The main circuit-breaker is protected from dirt and water by a rubber flap, which you can easily fold back.

## Charging fuse

The charging fuse is located above the main fuse on the bottom of the chassis by the right rear wheel. See fig. 8.

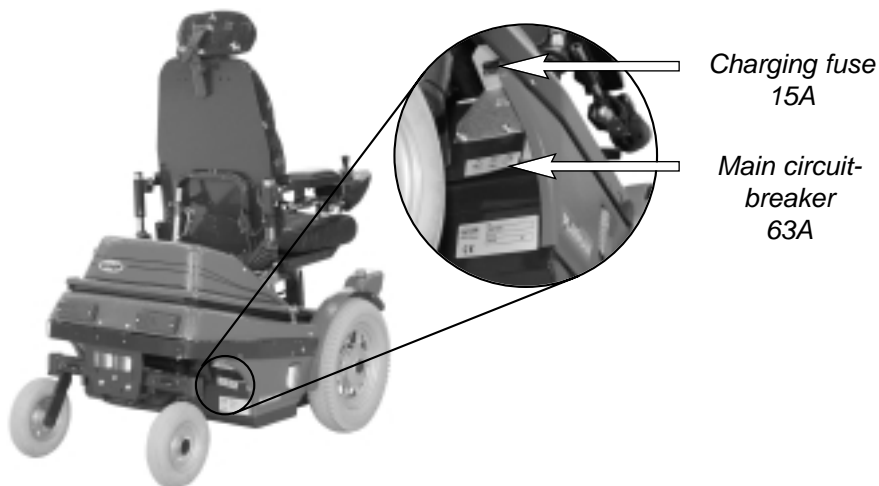

*Fig.8. Main circuit-breaker and charging fuse*

## Control panel

The control panel of the wheelchair is mounted on the right arm rest and its location can be adjusted to achieve the most comfortable position in connection with maneuvering. The control panel can also be mounted on the left arm rest. The Fig. 9 below shows the various functions of the control panel.

You can also have a seat control panel fitted to your wheelchair. You can then choose whether you want to adjust the electrical seat functions from the seat control panel.

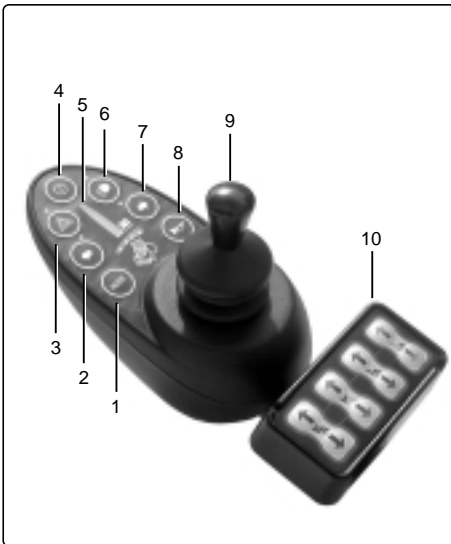

Fig. 9. Control panel

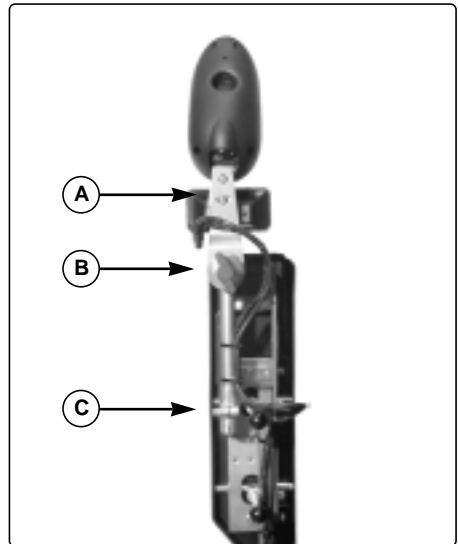

Fig. 10. Adjusting the control panel.

- |                              |                        |
|------------------------------|------------------------|
| 1. Selector                  | 6. Lights              |
| 2. Indicators                | 7. Indicators          |
| 3. Warning light             | 8. Horn                |
| 4. Switch, on/off            | 9. Joystick            |
| 5. Battery voltage indicator | 10. Seat control panel |

### A. Sideways adjustment

Loosen the screws and adjust the control panel to the desired position.

### B. Friction joint

Turn to adjust how light or stiff you want the sideways movement of the panel to be.

### C. Length adjustment

Loosen the screw and adjust the length as required.

### Security key

The security key can be used to lock the wheelchair to prevent unauthorized use. To lock the wheelchair it must be switched on, the key should then be inserted into and withdrawn from the panel outlet, the wheelchair will now be locked. The power can be shut off, if desired.

To unlock the wheelchair, be sure the chair’s power is “on”. The maximum speed indicator will ripple up and down but driving will not be possible. The key should now be inserted into and withdrawn from the panel outlet, the wheelchair can now be driven.



Fig. 11. Panel outlet with security key

### Start button

You use this button to start and stop the wheelchair. The start button must have been pressed for the chair to operate.



Fig. 12. Start button

### MODE (selector)

You use this switch to activate the speed selector and “Leverman” (see page 18).

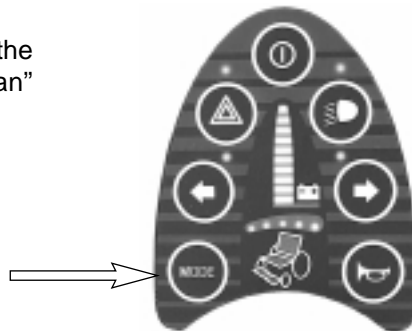

Fig. 13. Mode (selector)

**Battery voltage indicator**

The window display on the control panel (fig.14) shows the following indicator lights:

- Red+Yellow+Green = Fully charged
- Red+Yellow = Half charged
- Red = Charge the batteries



Fig.14. Battery voltage indicator

**Warning symbol**

When you press the switch, the indicator lamps flash on the control panel for the warning symbol (red lamp) and for both indicator lights (green lamp). If your wheelchair has lights, both indicator lamps flash too, to attract attention.

**NB!** This function works even when the start button is switched off

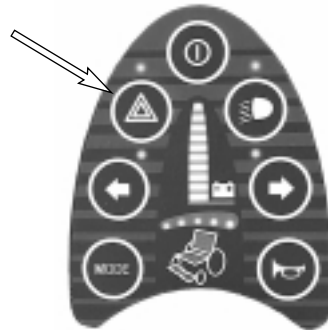

Fig. 15. Switch warning

**Speed selector**

The speed can be set in 5 stages, and one or more of the indicator lamps light depending on which speed range has been selected.

Setting speed, see page 18.

- 1 - 2 lamps = Low speed
- 2 - 4 lamps = Medium speed
- 5 lamps = Maximum speed



Fig. 16. Speed selector



**Lights**

Press the switch to turn on the lights of the wheelchair.

**Indicators**

Pressing the right or left arrow activates the chair's indicators.

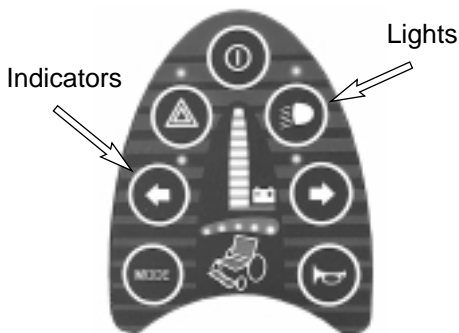

Fig. 17. Light/indicator switches

**Warning horn**

Press the button to sound the horn and attract attention.

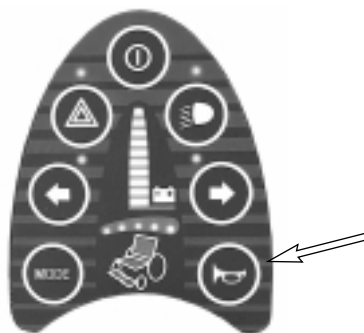

Fig. 18. Horn switch

**Joystick**

The joystick is used to regulate the speed of the wheelchair forwards or backwards, to turn and to brake.

The speed is regulated proportionally by moving the joystick forwards or backwards.

The speed is directly proportional to the movement of the joystick (small movement low speed - large movement high speed).

The wheelchair is turned by moving the joystick to the left or right.

The wheelchair is braked by moving the joystick back to the neutral position or letting it go.



Fig. 19. Joystick

## Leverman

Using Leverman adjust the speed of the wheelchair (5 positions), seat lift and seat lowering function with the joystick. Apart from speed, these functions can also be operated via the pushbuttons on the seat control panel.

### Operation of Leverman

1. Switch on the control panel using the switch.

2. Press the MODE button. The battery-indicator will light up and the lights on the speed selector will blink.

Increase or decrease the speed by moving the joystick to the right or to the left.

3. Press the MODE button to advance in the program.

The right footplate will light up.

4. Move the joystick to the right so the light on the seat lights up.

Move the joystick forward or backward to raise or lower the seat.

5. Move the joystick to the right so both the lights on the seat and at the rear light up.

This indicates the seat lowering function is activated and is controlled by moving the joystick forward or backward.

6. Press the MODE button to close the program and the chair is ready for operation.

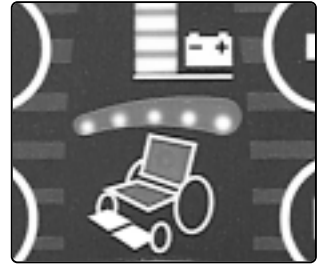

Fig. 20. No function



Fig.21. Seat lift



Fig.22. Seat lowering



Fig.23. No function

## Seat control panel

The seat control panel is attached to the right or left-hand armrest behind the control panel. The picture below show the different functions of the seat control panel.

### **Seat lift, fig. 24:1**

The seat is raised when the top part of the seat lift button is pressed, and lowered when the bottom part of the button is pressed.

### **Seat lowering, fig 24:3**

The seat is lowered when the top part of the seat lift button is pressed, and raised when the bottom part of the button is pressed.

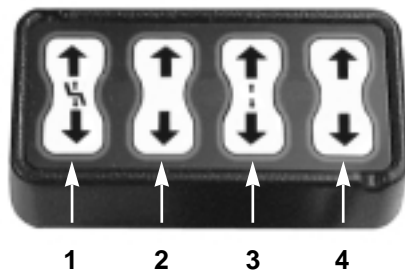

*Fig.24. Seat control panel*

1. Seat lift
2. No function
3. Seat lowering
4. No function

### **Joystick**

The joystick is used to regulate the speed of the wheelchair forwards or backwards, to turn and to brake.

### **Speed**

The speed is regulated proportionally by moving the joystick forwards or backwards. The speed is directly proportional to the movement of the joystick.

- Small movement = low speed.
- Large movement = high speed.



*Fig 25. Regulation of speed*

### Turning and braking

The wheelchair is turned by moving the joystick to the left or right.

The wheelchair is braked by moving the joystick back to the neutral position or letting it go.



*Fig 26. Regulation of turning*

## Accessory

We are constantly developing accessories for our wheelchairs. Contact your nearest Permobil retailer for more information about the accessories available for your wheelchair.

### Tool bag

The wheelchair is supplied with a tool bag which contains the following tools.



Fig. 27. Tool bag

<i>Tool</i>	<i>Area of use</i>
1. Pair of protective goggles	Work on the batteries
2. Set of Allen keys	General maintenance/adjustment
3. Security key	Lock/Unlock the wheelchair
4. 13 mm spanner	General maintenance, changing the battery
5. Screwdriver	General maintenance/removing the covers

# Handling

## General

This wheelchair is designed for use both inside and outside. When driving inside, take normal care. Outside you must remember to drive very slowly on steep downhill slopes and not to drive over curbs and other obstacles higher than 2.5".

Do not make the first test run on your own. The test run is to find out how you and the wheelchair work together and you may need some assistance.

## Driving

1. Switch on the wheelchair by pressing the start button on the control panel.

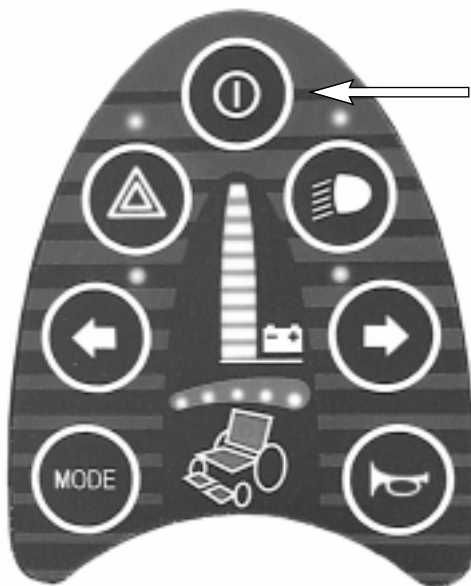
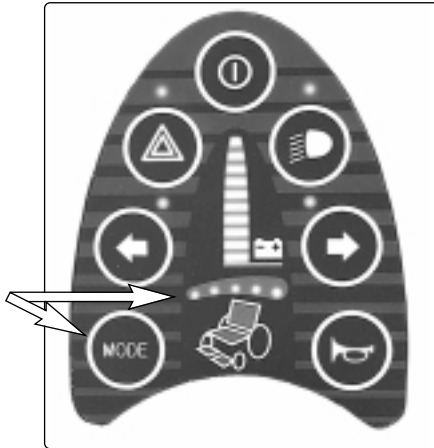

Fig. 28. Start button

- Set a suitable speed range by first pressing the MODE button and then use the joystick to select the speed, until the desired indicator lamp comes on for your type of driving.



Increase speed = Step to the right.  
Reduce speed = Step to the left.

1 - 2 lamps = Low speed  
3 - 4 lamps = Medium speed  
5 lamps = Maximum speed

*Fig. 29. Speed selector*

- Move the joystick carefully forwards to drive forwards, or backwards to reverse.

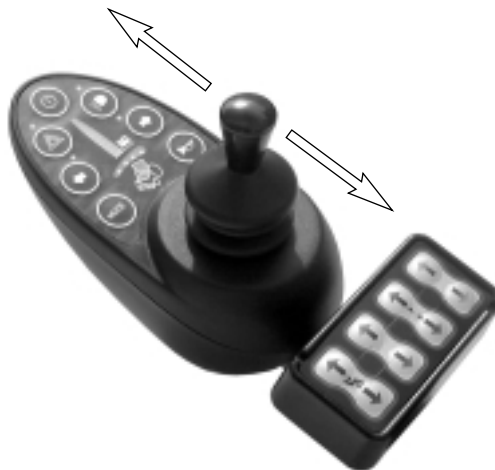

*Fig. 30. Driving forward/backwards*



- The speed of the wheelchair is regulated proportionally by moving the joystick forwards or backwards to different extents. The wheelchair's electronics make it possible to move slowly over curbs and other obstacles. You can drive up to the curb or obstacle and then carefully drive over it.

When you drive down an obstacle or a steep slope, you must drive slowly and brake gently. The maximum speed should be set to low speed. You can brake gently by pulling the joystick back to a position just before the neutral position. When the speed has been reduced, you can let the joystick go.

**NB!** The wheelchair moves at reduced speed if the seat is raised. You can only drive at full speed if the seat is in its lowest position. *Raising the seat lift raises the center of gravity and increases the risk of tipping. Therefore, you should only use the seat lift when driving on level ground and not on hilly ground.*

## Steering

The wheelchair can be turned in the required direction by moving the joystick to one side or the other while driving forwards or backwards



Fig. 31. Steering

## Driving rules

### High curbs and other obstacles



**WARNING !**

**Do not drive the wheelchair over curbs and other obstacles higher than 2.5".**



*Fig. 32. High curbs and other obstacles*

### Downhill slopes

When driving downhill, select the slowest speed and proceed with caution.



**WARNING !**

**Do not drive down slopes with a gradient greater than 12 degrees\*).**



*Fig. 33. Driving downhill*

\*)Dynamic stability according to ISO 7176-2 =6°

### Uphill slopes

If you drive up slopes steeper than  $12^{\circ}$ , there is a risk that the wheelchair cannot be maneuvered safely.



**WARNING !**

**Do not drive up slopes steeper than 12 degrees.**



*Fig. 34. Driving uphill*

### Driving along slopes



**WARNING !**

**Do not drive the wheelchair along slopes steeper than 6 degrees. There is a risk of tipping.**

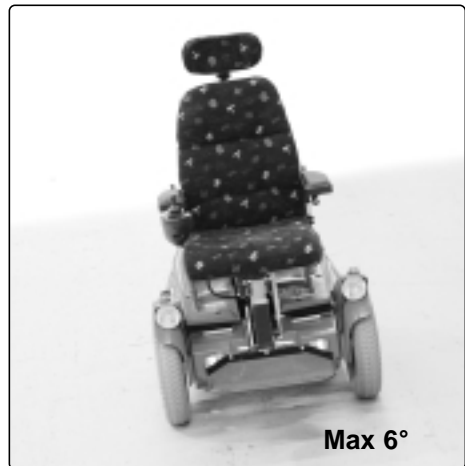

*Fig. 35. Driving along slopes*

## Releasing the brakes



**WARNING !**

**In order to avoid the wheelchair rolling away, ensure that the wheelchair is on a level and dry base before releasing the brakes.**

The brakes can be released to make it possible to move the wheelchair manually.

1. Switch off the wheelchair by switching off the main power switch.
2. Move the lever forwards (fig. 36). The chair can now be moved manually.

Check regularly, approx. once per month, the brake release function by engaging and disengaging the brake release a number of times. Check to see if chair actually goes in and out of freewheel by pushing the chair.

**NB!** Reset the brakes after moving the chair by pulling the lever backwards. When the brake release has been activated, the wheelchair cannot be driven.

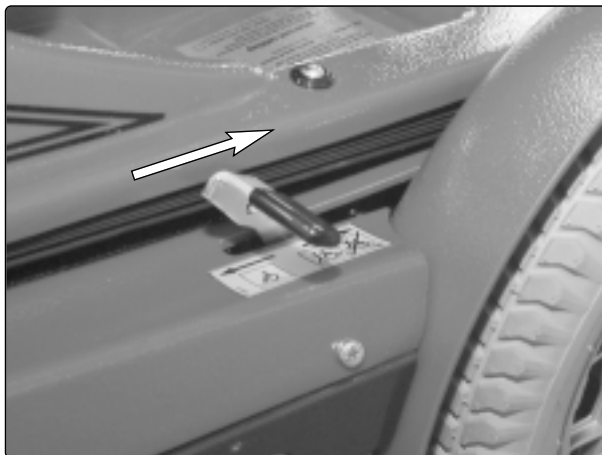

*Fig. 36. Releasing the brakes*

## Battery charging



**WARNING !**

Only carry out charging in a well-ventilated area, not a wardrobe etc. Do not charge up in a bathroom or other wet room.



**WARNING !**

Be careful with metal objects when working on the batteries. A short circuit could easily cause an explosion. Always wear safety gloves and goggles.



**WARNING !**

Use only chargers with a maximum 10 A charging current (mean value). (The effective value of the charging current must not exceed 12 A.)



*Fig. 37. Lester Electrical's Dual mode charger*

### **When should the batteries be charged?**

As a general rule, you should recharge your batteries as frequently as possible to assure the longest possible life and to minimize the required charging time. Plan to recharge them when you do not anticipate using the chair for a long period of time.

A battery voltage indicator on the control panel indicates when the battery voltage is low. The batteries must then be charged as soon as possible.

If the batteries should become completely discharged, it is important that you recharge them as soon as possible. If you delay before recharging them, the batteries can be damaged.

### **Charging**

1. Connect the power cable to the outlet. Turn off charger first, then, after connecting, turn on charger.
2. Connect the connection cable from the charger to the charging socket on the wheelchair, which is under the rubber shield on the right side of the cover.

**NB!** When the charger is connected, the chair must not and cannot be driven.

***Description and Use of Battery Charger, see supplied Instruction Manual.***



*Fig. 38. Connecting the charger*

## Transport

The Permobil can be locked in place with loading belts attached to the front wheels and the rear tie-down points. If the chair has to be transported in a mini van or other vehicle it is vital that the chair is properly fixed and that the fixing points used are well anchored.



**WARNING !**

---

**A poorly fixed chair can cause serious injury to passengers if it comes loose, not to mention damage to the vehicle and the wheelchair itself.**

---

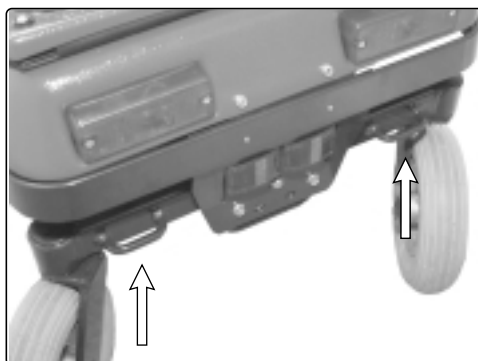

*Fig.39. Rear tie-down points*

## Air transport

When transporting your chair by air, you should be aware of three things above all: the batteries, the dimensions and weight of the wheelchair and that the seat can be damaged when handled as it is placed together with luggage and other goods in a narrow space.

### Batteries

If the wheelchair is equipped with maintenance-free gel batteries; in some airlines it is not necessary to remove the batteries from the wheelchair during the flight. However, the electrical connections to the battery must be disconnected and insulated. Check with your airline which rules apply.

If a wheelchair is equipped with acid batteries, most airlines require that the batteries shall be removed from the wheelchair and transported in special boxes provided by the airline.

Some airlines refuse to take acid batteries aboard at all, so always check with the airline in question which rules apply.

See page 37-38 for how to remove the batteries.

### The dimensions and weight of the wheelchair

The weight and dimensions of the wheelchair are significant in relation to the type of airplanes in which the wheelchair is to be transported. The smaller the airplane, the smaller the wheelchair may be/the less it may weigh and vice versa. Always check with the airline in question which rules apply.

### Preventing damage

Cover the maneuvering panel with soft, shock-absorbing material (foamed plastic or similar) and fold it in towards the back rest. Protect other salient objects in similar fashion. Tape any loose cables to the seat or covers.

### NB!

To ensure that the chair is transported safely and that no nasty surprises pop up at the last minute, ***always contact the airline with which you are travelling beforehand.***



## Maintenance



**WARNING !**

---

**Before working on the wheelchair's electrical system the connection to the positive pole of the battery must always be removed.**

---



**WARNING !**

---

**Be careful with any metal objects when working on the battery. A shortcircuit could easily cause an explosion. Always wear safety gloves and goggles.**

---



**WARNING !**

---

**Make sure nothing is trapped between the chassis and the seat when operating the seat lift.**

---

## General

For optimum performance of your wheelchair it is important to take good care of it.

All wheelchairs are subject to wear, partly due to moving parts and partly due to stresses.

What you need to know is how your wheelchair works, how to drive and use it in the best way and how to take regular care of it.

The purpose of preventive maintenance is to prevent problems arising. If you look after your wheelchair it will function well and the risk of faults will be reduced.

## Cleaning

Clean the wheelchair often. After use outdoors it should be cleaned even more thoroughly. Use a damp cloth with a mild soap solution to wipe off dirt and dust.

Once in a while remove the battery and chassis covers and clean them thoroughly, wiping their undersides with a damp cloth.

**NB!** Do not hose down your wheelchair! The electronics may be damaged.

## Wheels

Regularly check the wheels for the correct tire pressure. Top up the air if necessary. See page 39.

## Check of brake release

Check regularly, approx. once per month, the brake release function by engaging and disengaging the brake release a number of times.

## Batteries

### Storage

Note that a battery will run down of its own accord and a run-down battery will be ruined if it freezes in cold weather. If the wheelchair is to be kept unused for a lengthy period, the batteries must always be recharged once a month to prevent damage.

**NB!** The temperature in the place of storage must not fall below 41°F.

The Chairman Playman has maintenance-free gel-type batteries. This means there is no need to check fluid levels.

Battery life depends entirely on regular charging.



*Fig. 40. Batteries*

## Repairs

### Resetting the main fuse/battery cut-out

The main fuse also functions as a battery cut-out but is still referred to as the main fuse in the user instruction.

**NB!** First switch off the power on the maneuvering panel before switching the power off on the main fuse.

#### Main fuse

You don't normally need to change the main fuse, as you can reset it when it trips. You reset it by switching it to the "ON" position. The main fuse is under the chassis, over the right, rear wheel, see fig. 41.

**NB!** If the main fuse trips, it usually means that there is a serious electrical fault. Check the cause carefully before you reset the circuit breaker.

#### Charging fuse

The charging fuse is next to the main circuit-breaker, see fig. 41.

**NB!** The wheelchair should be inoperative when you change the charging fuse.

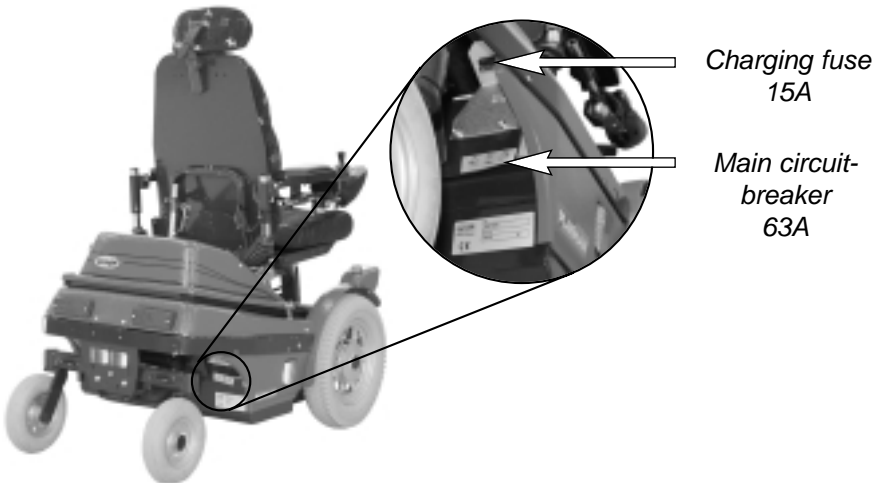

*Fig.41. Main circuit-breaker and charging fuse*

## Changing bulbs

### Front lights

1. Unscrew the two Allen screws (figure 42:1) on the top of the lamp cover.
2. Pull the reflector forwards.
3. Unscrew the two Phillips screws on the rear of the lamp holder and remove the reflector.
4. Change the bulb.

### Front indicators

1. Turn the indicator glass (figure 42:2) 90° anticlockwise.
2. Lift the indicator glass straight up (do not screw).
3. Change the bulb.

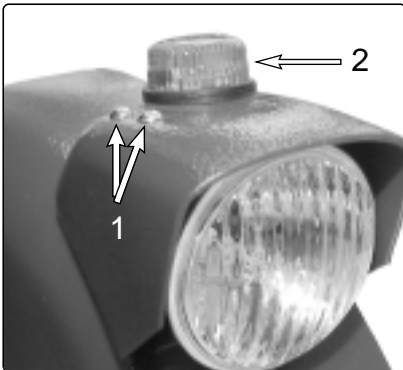

Fig.42. Front light

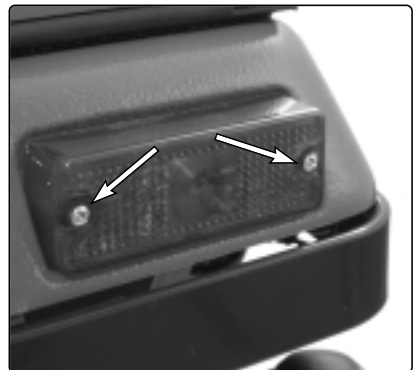

Fig.43. Rear light

### Rear lights and indicators

1. The rear indicator bulb (upper bulb) and rear light bulb (lower bulb) can be changed after you have loosened the screws on the glass of the rear light (fig. 43).

Bulbs	Socket type	Power
Headlamps	R10/E10	24V/3W
Front indicators	13256	24V/3W
Rear lights	SP36	24V/3W
Rear indicators	SP36	24V/3W

## Changing the batteries

1. Place the Permobil wheelchair on a level base.
2. Raise the seat lift to its highest position.
3. Unscrew the screws (4 screws). Remove the rear covers. Be careful when you remove the lower cover as the cables for the rear lights are fastened to it.

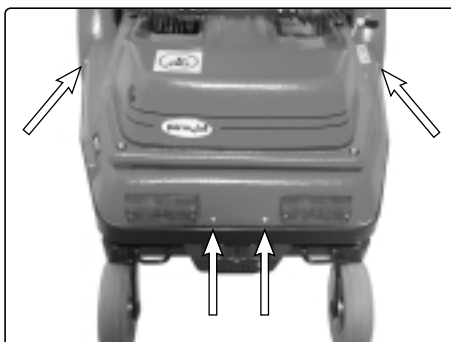

*Fig.44. Rear cover screws*

4. Loosen the nuts (fig. 45) two turns, pull the guide yoke upwards.

**NB!** This work is best performed by two people; one to loosen the nuts and pull up the guide yoke and another to hold the seat and prevent it from falling. If you are working on your own, get a good hold of the seat and check that no one is directly in front of the chair before you pull the guide yoke upwards.

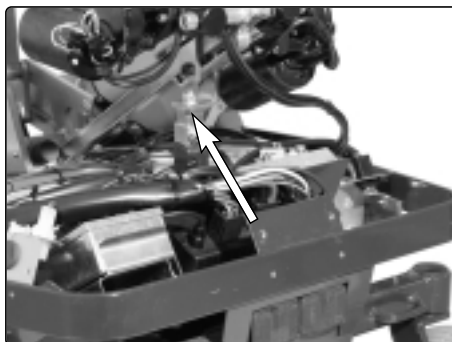

*Fig.45. Guide yoke nuts*

5. Disconnect the battery connections. Disconnect the positive poles first and then the negative poles.
  6. Lift out the batteries.
  7. Insert two new batteries.
- NB!** Position.
8. Connect the battery connections, first the negative poles and then the positive poles.

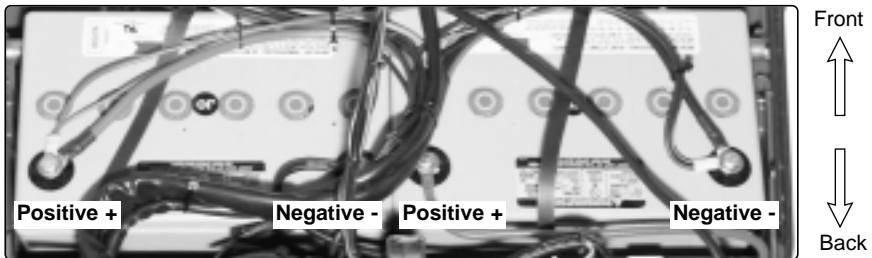

*Fig.46. Batteries*

**NB!** If the batteries are empty or an electronics fault has occurred and the seat is not raised, the adjustment device for the “terra” function must be loosened. This is done as follows:

Remove the black plastic plug (fig. 47) and unscrew and remove the Allen screw. Get a good hold on the seat and pull it forwards/upwards until the foot plate is resting on the floor. Lift off the top cover, which is fixed with Velcro. The chair is now accessible for service. For reassembly: move the seat back to the initial position and screw the adjustment device in place. Move the seat forwards and refit the cover.

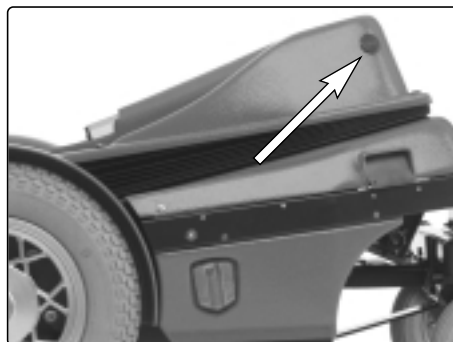

*Fig.47. Plug*

## Changing inner tubes

1. Block up the wheelchair and let out the air.
2. Pull the tire off the wheel rim.
3. Change the punctured inner tube.
4. Replace the tire on the wheel rim and fill with air.

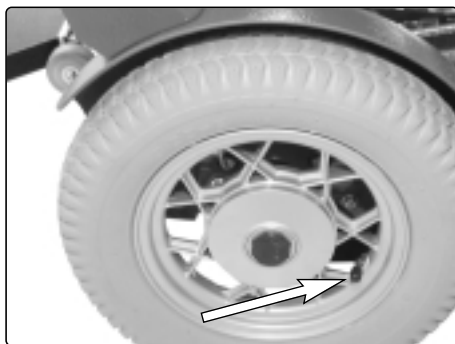

*Fig.48. Filling valve*

## Filling with air



**WARNING !**

**The recommended air pressure is 29 psi. Overfilling entails the risk of explosion.**

Low air pressure in the tires produces abnormal wear and reduces the range. Therefore, check regularly that the front tires have a pressure of 29 psi.

1. Unscrew and remove the plastic caps on the air valves on the drive wheels.
2. Connect the compressed air nozzle to the air valve and adjust the tire pressure to the prescribed level.

## Specifications and performance

Length	45"
Width	25"
Transport dimension	33"
Seat height	21"
Seat height with electric seat lift	6" - 28"
Weight including batteries	286 lbs
Battery capacity	2x73 Ah
Charging time	ca. 8 h
Driving range	19 - 25 miles
Maximum speed	4.7 mph
Stopping distance	47"
Turning circle 180°	27"
Obstacle ability	2,5"
Max weight of user	77 lbs
Air pressure of front tires	29 psi
Seat width	10" - 12"/14"
Seat depth	11"/13"/15"
Backrest height	13"/15"/17"
Armrest height	6" - 11"
Distance between armrests	10" - 14"
Distance between seat cushion and footplate	5" - 13"
Adjustable backrest angle	90°-165° manually
Adjustable footrest angle	90°-110° manually



## Electrical system

### Electronics

PM80 Pilot+

### Control panel

JSM-L 7key Pilot+

### Batteries

Recommended battery type ..... Group 24, Gel

Battery capacity ..... 2 x 73Ah

Charging time ..... 8 hours

### Fuses

Charging fuse ..... 15A

Mainfuse ..... 63A

***CAUTION! It is very important that you read this information regarding the possible effects of electromagnetic interference on your powered wheelchair.***

## **Electromagnetic Interference (EMI) From Radio Wave Sources**

Powered wheelchairs and motorized scooters (in this text, both will be referred to as powered wheelchairs) may be susceptible to electromagnetic interference (EMI), which is interfering electromagnetic energy (EM) emitted from sources such as radio stations, TV stations, amateur radio (HAM) transmitters, twoway radios, and cellular phones.

The interference (from radio wave sources) can cause the powered wheelchair to release its brakes, move by itself, or move in unintended directions. It can also permanently damage the powered wheelchair's control system. The intensity of the interfering EM energy can be measured in volts per meter (V/m). Each powered wheelchair can resist EMI up to a certain intensity. This is called its "immunity level". The higher the immunity level, the greater the protection.

At this time, requested immunity level as per EN 60601-1-2 is 3 V/m. The immunity level of this powered wheelchair model as shipped, with no further modification, is >20V/m in the range of 26 MHz to 950 MHz.

There are a number of sources of relatively intense electromagnetic fields in the everyday environment. Some of these sources are obvious and easy to avoid. Others are not apparent and exposure is unavoidable. However, we believe that by following the warnings listed below, your risk to EMI will be minimized.

The sources of radiated EMI can be broadly classified into three types:

### **1.**

***Hand-held portable transceivers*** (transmitters-receivers) with the antenna mounted directly on the transmitting unit. Examples includes: citizens band (CB) radios, "walkie talkie", security, fire, and police transceivers, cellular telephones, and other personal communication devices.

**NB!** Some cellular telephones and similar devices transmit signals while they are ON, even when not being used.

### **2.**

***Medium-range mobile transceivers***, such as those used in police cars, fire trucks, ambulances, and taxis. These usually have the antenna mounted on the outside of the vehicle.

**3.**

**Long-range transmitters and transceivers**, such as commercial broadcast transmitter (radio and TV broadcast antenna tower) and amateur (HAM) radios.

**NOTE!** Other types of hand-held devices, such as cordless phones, laptop computers, AM/FM radios, TV sets, CD players, and cassette players, and small appliances, such as electric shavers and hair dryers, so far we know, are not likely to cause EMI problems to your powered wheelchair.

Because EM energy rapidly becomes more intense as one moves closer to the transmitting antenna (source), the EM fields from hand-held radio wave sources (transceivers) are of special concern. It is possible to unintentionally bring high levels of EM energy very close to the powered wheelchair's control system while using these devices. This can affect powered wheelchair movement and braking. Therefore, the warnings listed below are recommended to prevent possible interference with the control system of the powered wheelchair.

**WARNINGS**

Electromagnetic interference (EMI) from sources such as radio and TV stations, amateur radio (HAM) transmitters, two-way radios, and cellular phones can affect powered wheelchairs and motorized scooters. Following the warnings listed below should reduce the chance of unintended brake release or powered wheelchair movement which could result in serious injury.

**1.**

Do not operate hand-held transceivers (transmitters/receivers), such as citizens band (CB) radios, or turn ON personal communications devices, such as cellular phones, while the powered wheelchair is turned ON.

**2.**

Be aware of nearby transmitters, such as radio or TV stations, and try to avoid coming close to them.

**3.**

If unintended movement or brake release occurs, turn the powered wheelchair OFF as soon as it is safe.

**4.**

Be aware that adding accessories or components, or modifying the powered wheelchair, may make it more susceptible to EMI.

*(Note: There is no easy way to evaluate their effect on the overall immunity of the powered wheelchair).*

**5.**

Report all incidents of unintended movement or brake release to the powered wheelchair manufacturer, and note whether there is a radio wave source nearby.









